

# ESTATE Table

## Zenith



### Features:

Estate is a comprehensive family of tables that provide permanent 'localities' for divergent tasks. Serving as either an individual work-point table or a collaboration setting, Estate creates a 'home base' for specific modes of work. Distinguished by the grounded pedestals which come in a selection of profiles, Estate can be configured in ways that best align with varying work tasks and design aspirations.

### Options:

- Round & Capsule Fixed Height Pedestal Table
  - Single, Twin or Triple
- Capsule Fixed Height Modesty Pedestal Table
  - Single or Twin
- Capsule Plus Fixed Height Pedestal Table
  - Single
- Capsule Plus Electric Adjust Pedestal Table
  - Single, Single Sided or Pod 2
- Collaborative & Work-point settings:
  - Collaborative setting: The table is intended for meetings/collaborative projects where the number of users fluctuates depending on the task
  - Work-point setting: The table is intended for individual work where users have their own defined space and the quantity of work-points is pre-defined
- Fixed, Above floor or Access floor Bases
- Foot Rail (1050 Fixed Height only), Sky Rail or Ctrl Screen Rail (Capsule Plus Electric Adjust Single Sides & Pod 2 only)
- Ctrl Screens (Sky Rail & Ctrl Screen Rail only)
- Cable Management: Fully Concealed Cabling, Central Click-in Access Lids & Powder/Data frame Mounting Plates
- Floorsense puck

**Design:** ZENITH DESIGN STUDIO

**Warranty:** 10 years

**Certification:** GECA, Greenguard, AFRDI (Capsule Table with Floating Base only)

**Load Rating:** Maximum dynamic load limit for all electric desks is 100kg including the worktop weight.

### Finishes:

Worktop & Click-in Lids: 25mm laminate.  
Pedestal Shrouds, Table Support Frame, Cable Management, Foot Rail, & Sky Rail: Powder coated in Zenith House Satin/ Matt/Fine Texture range  
Custom colours on request

### Zenith House Powder Coat:



Note:  
Fine Texture is not suitable on Estate Capsule Plus

## Round & Capsule Fixed Height Pedestal - Single

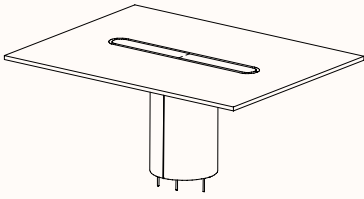

**Round Single Pedestal with Fixed Base**  
(Bolt to Slab)

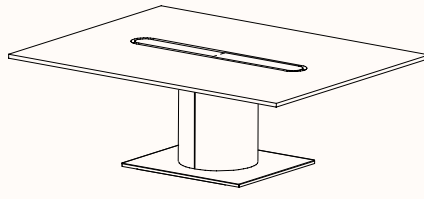

**Round Single Pedestal with Above Floor Base**  
(Floating Base)

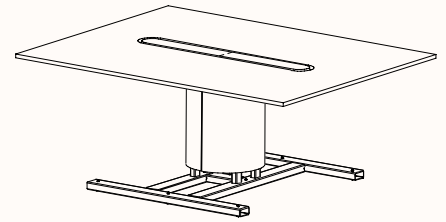

**Round Single Pedestal with Access Floor Base**  
(Floating Base)

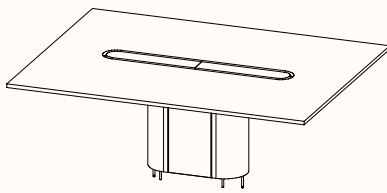

**Capsule Single Pedestal with Fixed Base**  
(Bolt to Slab)

Table length range: 1200 - 3200mm  
Table depth range: 1200 - 1800mm

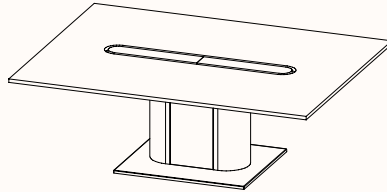

**Capsule Single Pedestal with Above Floor Base**  
(Floating Base)

Table length range: 1200 - 1800mm  
Table depth range: 1200 - 1600mm

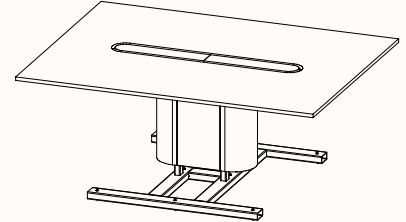

**Capsule Single Pedestal with Access Floor Base**  
(Floating Base)

Table length range: 1200 - 1800mm  
Table depth range: 1200 - 1600mm

Suitable for use as a Collaborative\* or Work-point\*\* setting

**Note \*** Collaborative settings: The worktop pieces and joins will be calculated to provide the best board efficiency

**\*\*** Work-point settings: The number of work-points must be specified.

The individual work-point length limitations are minimum 1200mm to maximum 2400mm.

Each work-point on the table will be equal in length.

### Height Range

Fixed Height: 720mm, 750mm, 900mm & 1050mm

### Options

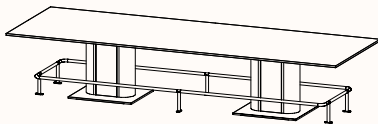

#### Foot Rail

Available on 1050mmH tables only

**Collaborative Setting:** The vertical support post quantity & spacing will be calculated to ensure strength & stability.

**Work-Point Setting:** Vertical support posts will be spaced according to the number of seating positions.

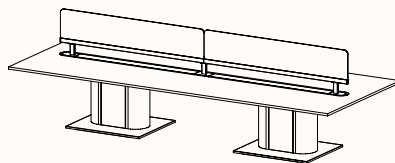

#### Sky Rail

Consists of an elevated Ctrl Screen Rail

Compatible with Ctrl Screens

The quantity of posts is calculated to ensure strength & stability.

Sky Rail: Comes with click-in lids between the vertical posts

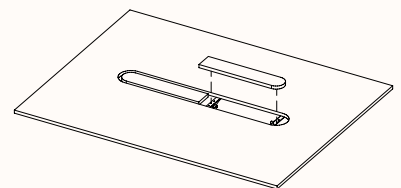

#### Click-in Lids

Provide quick and easy access to Power/data outlets under the worktop  
Capsule shaped

The quantity of lids is calculated to ensure ease of use.

## Round & Capsule Fixed Height Pedestal - Twin

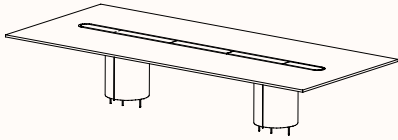

**Round Twin Pedestal with Fixed Base**  
(Bolt to Slab)

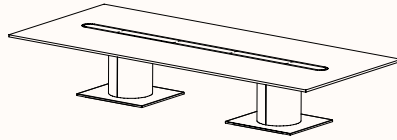

**Round Twin Pedestal with Above Floor Base**  
(Floating Base)

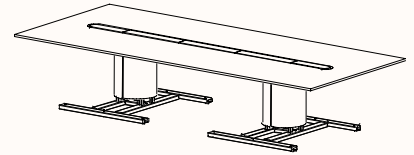

**Round Twin Pedestal with Access Floor Base**  
(Floating Base)

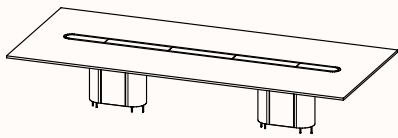

**Capsule Twin Pedestal with Fixed Base**  
(Bolt to Slab)

Table length range: 3200 - 6800mm  
Table depth range: 1200 - 1800mm

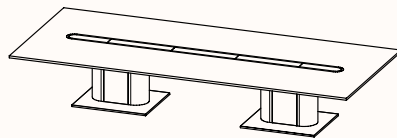

**Capsule Twin Pedestal with Above Floor Base**  
(Floating Base)

Table length range: 2800 - 6000mm  
Table depth range: 1200 - 1600mm

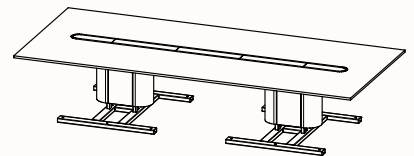

**Capsule Twin Pedestal with Access Floor Base**  
(Floating Base)

Table length range: 2800 - 6000mm  
Table depth range: 1200 - 1600mm

Suitable for use as a Collaborative\* or Work-point\*\* setting

**Note \*** Collaborative settings: The worktop pieces and joins will be calculated to provide the best board efficiency

**\*\*** Work-point settings: The number of work-points must be specified.

The individual work-point length limitations are minimum 1200mm to maximum 2400mm.

Each work-point on the table will be equal in length.

### Height Range

Fixed Height: 720mm, 750mm, 900mm & 1050mm

### Options

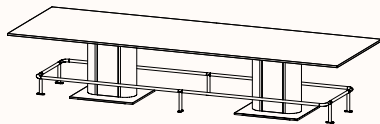

#### Foot Rail

Available on 1050mmH tables only

**Collaborative Setting:** The vertical support post quantity & spacing will be calculated to ensure strength & stability.

**Work-Point Setting:** Vertical support posts will be spaced according to the number of seating positions.

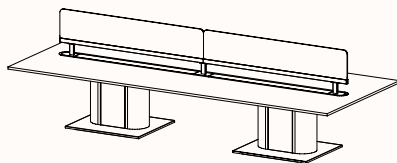

#### Sky Rail

Consists of an elevated Ctrl Screen Rail

Compatible with Ctrl Screens

The quantity of posts is calculated to ensure strength & stability.

Sky Rail: Comes with click-in lids between the vertical posts

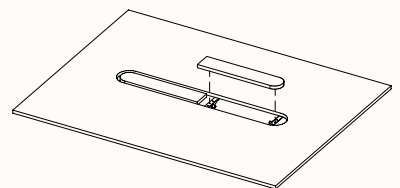

#### Click-in Lids

Provide quick and easy access to Power/data outlets under the worktop  
Capsule shaped

The quantity of lids is calculated to ensure ease of use.

## Round & Capsule Fixed Height Pedestal - Triple

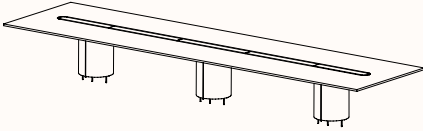

**Round Triple Pedestal with Fixed Base**  
(Bolt to Slab)

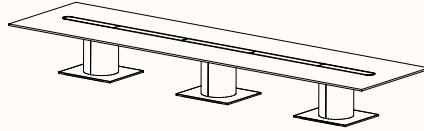

**Round Triple Pedestal with Above Floor Base**  
(Floating Base)

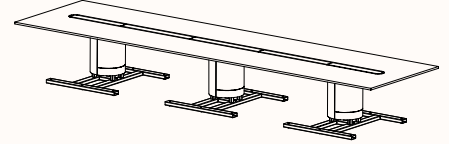

**Round Triple Pedestal with Access Floor Base**  
(Floating Base)

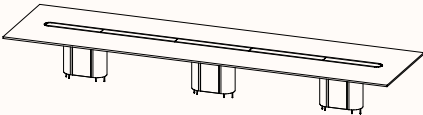

**Capsule Triple Pedestal with Fixed Base**  
(Bolt to Slab)  
Table length range: 6800 - 10000mm  
Table depth range: 1200 - 1800mm

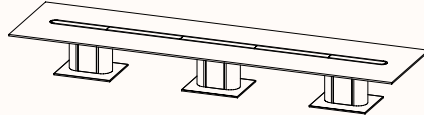

**Capsule Triple Pedestal with Above Floor Base**  
(Floating Base)  
Table length range: 5600 - 8400mm  
Table depth range: 1200 - 1600mm

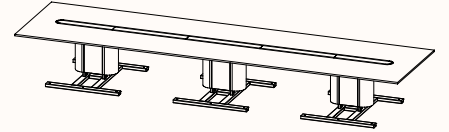

**Capsule Triple Pedestal with Access Floor Base**  
(Floating Base)  
Table length range: 5600 - 8400mm  
Table depth range: 1200 - 1600mm

Suitable for use as a Collaborative\* or Work-point\*\* setting

**Note \*** Collaborative settings: The worktop pieces and joins will be calculated to provide the best board efficiency

**\*\*** Work-point settings: The number of work-points must be specified.

The individual work-point length limitations are minimum 1200mm to maximum 2400mm.

Each work-point on the table will be equal in length.

### Height Range

Fixed Height: 720mm, 750mm, 900mm & 1050mm

### Options

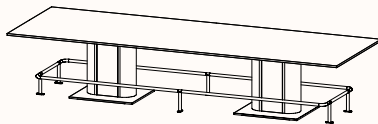

#### Foot Rail

Available on 1050mmH tables only

**Collaborative Setting:** The vertical support post quantity & spacing will be calculated to ensure strength & stability.

**Work-Point Setting:** Vertical support posts will be spaced according to the number of seating positions.

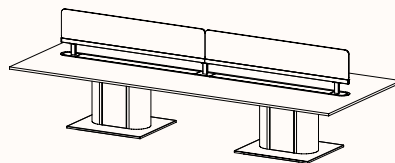

#### Sky Rail

Consists of an elevated Ctrl Screen Rail

Compatible with Ctrl Screens

The quantity of posts is calculated to ensure strength & stability.

Sky Rail: Comes with click-in lids between the vertical posts

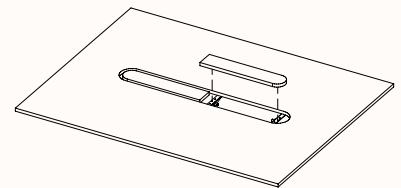

#### Click-in Lids

Provide quick and easy access to Power/data outlets under the worktop  
Capsule shaped

The quantity of lids is calculated to ensure ease of use.

## Capsule Modesty Fixed Height Pedestal – Single

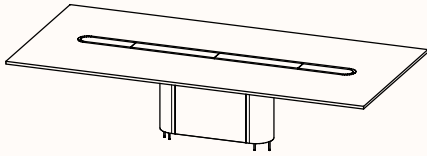

### Capsule Modesty Single Pedestal with Fixed Base

(Bolt to Slab)

Table length range: 1800 – 3600mm

Table depth range: 1200 – 1800mm

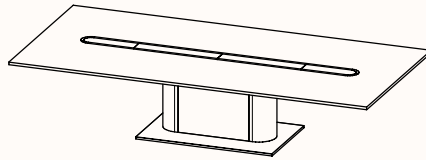

### Capsule Modesty Single Pedestal with Above Floor Base

(Floating Base)

Table length range: 1800 – 3200mm

Table depth range: 1200 – 1600mm

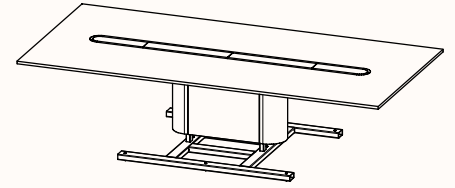

### Capsule Modesty Single Pedestal with Access Floor Base

(Floating Base)

Table length range: 1800 – 3200mm

Table depth range: 1200 – 1600mm

Suitable for use as a Collaborative\* or Work-point\*\* setting

**Note \*** Collaborative settings: The worktop pieces and joins will be calculated to provide the best board efficiency

**\*\*** Work-point settings: The number of work-points must be specified.

The individual work-point length limitations are minimum 1200mm to maximum 2400mm.

Each work-point on the table will be equal in length.

### Height Range

Fixed Height: 720mm, 750mm, 900mm & 1050mm

## Options

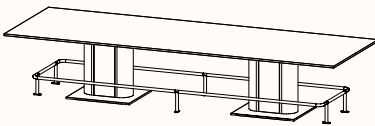

### Foot Rail

Available on 1050mmH tables only

**Collaborative Setting:** The vertical support post quantity & spacing will be calculated to ensure strength & stability.

**Work-Point Setting:** Vertical support posts will be spaced according to the number of seating positions.

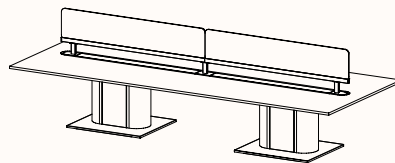

### Sky Rail

Consists of an elevated Ctrl Screen Rail

Compatible with Ctrl Screens

The quantity of posts is calculated to ensure strength & stability.

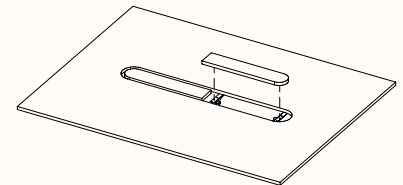

### Click-in Lids

Provide quick and easy access to Power/data outlets under the worktop  
Capsule shaped

The quantity of lids is calculated to ensure ease of use.

## Capsule Modesty Fixed Height Pedestal – Twin

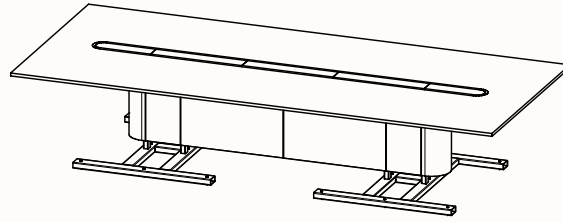
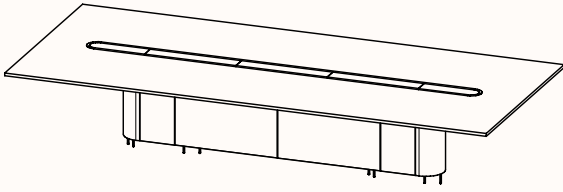

### Capsule Modesty Twin Pedestal with Fixed Base

(Bolt to Slab)

Table length range: 2800 – 5600mm

Table depth range: 1200 – 1800mm

### Capsule Modesty Twin Pedestal with Access Floor Base

(Floating Base)

Table length range: 2800 – 5600mm

Table depth range: 1200 – 1600mm

Suitable for use as a Collaborative\* or Work-point\*\* setting

**Note \*** Collaborative settings: The worktop pieces and joins will be calculated to provide the best board efficiency

**\*\*** Work-point settings: The number of work-points must be specified.

The individual work-point length limitations are minimum 1200mm to maximum 2400mm.

Each work-point on the table will be equal in length.

### Height Range

Fixed Height: 720mm, 750mm, 900mm & 1050mm

## Options

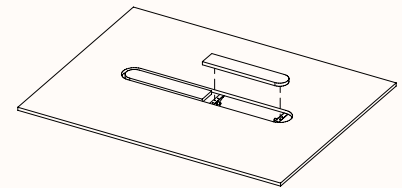
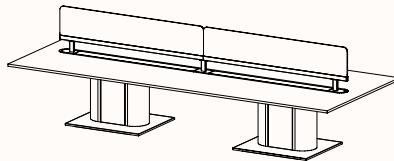
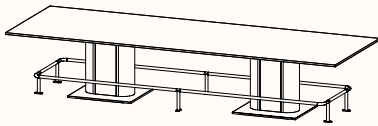

### Foot Rail

Available on 1050mmH tables only

**Collaborative Setting:** The vertical support post quantity & spacing will be calculated to ensure strength & stability.

**Work-Point Setting:** Vertical support posts will be spaced according to the number of seating positions.

### Sky Rail

Consists of an elevated Ctrl Screen Rail

Compatible with Ctrl Screens

The quantity of posts is calculated to ensure strength & stability.

### Click-in Lids

Provide quick and easy access to

Power/data outlets under the worktop

Capsule shaped

The quantity of lids is calculated to ensure ease of use.

## Capsule Plus Fixed Height Pedestal - Single

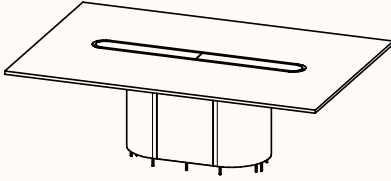

### Capsule Plus Single Pedestal with Fixed Base

(Bolt to Slab)

Table length range: 1600 - 3600mm

Table depth range: 1500 - 2000mm

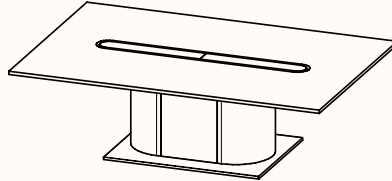

### Capsule Plus Single Pedestal with Above Floor Base

(Floating Base)

Table length range: 1600 - 3200mm

Table depth range: 1500 - 1800mm

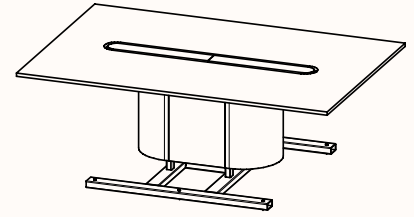

### Capsule Plus Single Pedestal with Access Floor Base

(Floating Base)

Table length range: 1600 - 3200mm

Table depth range: 1500 - 1800mm

Suitable for use as a Collaborative\* or Work-point\*\* setting

**Note \*** Collaborative settings: The worktop pieces and joins will be calculated to provide the best board efficiency

**\*\*** Work-point settings: The number of work-points must be specified.

The individual work-point length limitations are minimum 1200mm to maximum 2400mm.

Each work-point on the table will be equal in length.

### Height Range

Fixed Height: 720mm, 750mm, 900mm & 1050mm

## Options

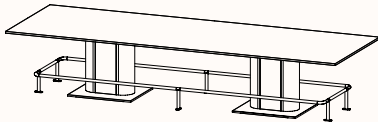

### Foot Rail

Available on 1050mmH tables only

**Collaborative Setting:** The vertical support post quantity & spacing will be calculated to ensure strength & stability.

**Work-Point Setting:** Vertical support posts will be spaced according to the number of seating positions.

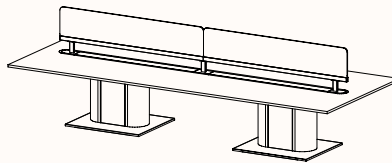

### Sky Rail

Consists of an elevated Ctrl Screen Rail

Compatible with Ctrl Screens

The quantity of posts is calculated to ensure strength & stability.

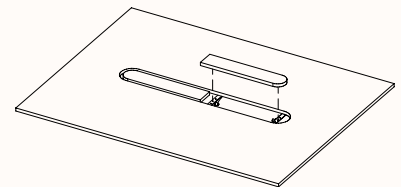

### Click-in Lids

Provide quick and easy access to Power/data outlets under the worktop  
Capsule shaped

The quantity of lids is calculated to ensure ease of use.

## Capsule Plus Electric Adjust Pedestal – Single

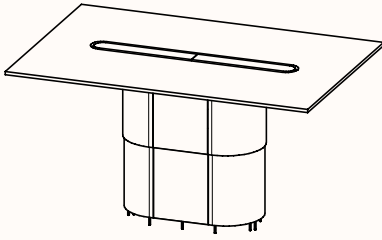

### Capsule Plus Single Pedestal with Fixed Base

(Bolt to Slab)

Table length range: 1600 – 2400mm

Table depth range: 1500 – 1800mm

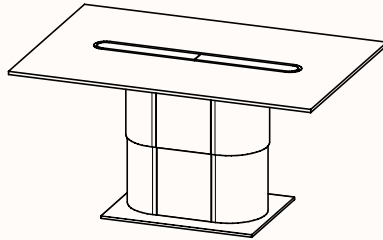

### Capsule Plus Single Pedestal with Above Floor Base

(Floating Base)

Table length range: 1600 – 2400mm

Table depth range: 1500 – 1600mm

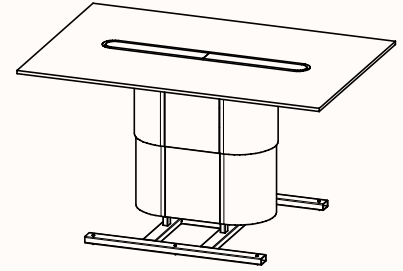

### Capsule Plus Single Pedestal with Access Floor Base

(Floating Base)

Table length range: 1600 – 2400mm

Table depth range: 1500 – 1600mm

Suitable for use as a Collaborative\* setting

**Note \*** Collaborative settings: The worktop pieces and joins will be calculated to provide the best board efficiency

### Height Range

Electric Adjust: 670 – 1200mm

### Options

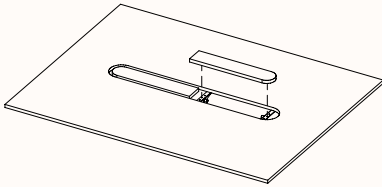

### Click-in Lids

Provide quick and easy access to

Power/data outlets under the worktop

Capsule shaped

The quantity of lids is calculated to ensure ease of use.



## Capsule Plus Electric Adjust – Single Sided

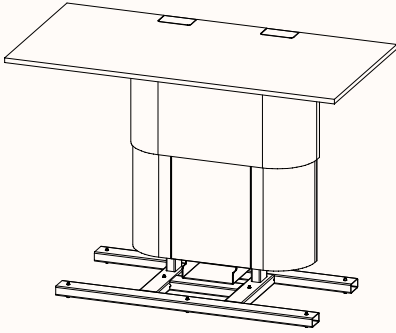

### Capsule Plus Single Sided with Access Floor Base

(Floating Base)

Table length range: 1400 – 1800mm

Table depth range: 750 – 900mm

Suitable for use as a Work-point setting.

Available with Click-in Lids which provide quick and easy access to Power/data outlets under the worktop. Capsule shaped. The quantity of lids is calculated to ensure ease of use.

### Height Range

Electric Adjust: 670 – 1200mm

## Options

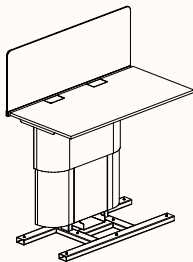

### Ctrl Screen Rail & Ctrl Screen

Compatible with Ctrl Screen Rail  
(Worktop Mounted) & Ctrl Screen

Rear worktop to Ctrl Rail gap = Zero – 30mm

## Capsule Plus Electric Adjust – Pod 2

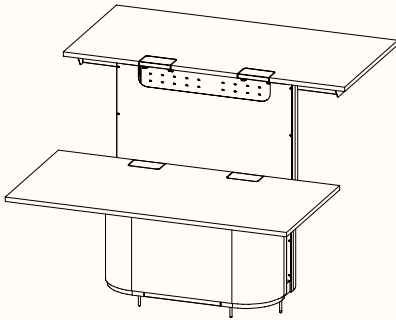

### Capsule Plus Pod 2 with Fixed Base

(Bolt to Slab)

Table length range: 1400 - 1800mm

Table depth range: 750-900mm

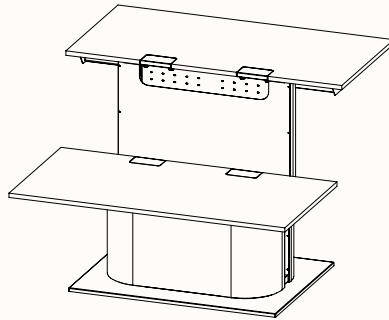

### Capsule Plus Pod 2 with Above Floor Base

(Floating Base)

Table length range: 1400 - 1800mm

Table depth range: 750-900mm

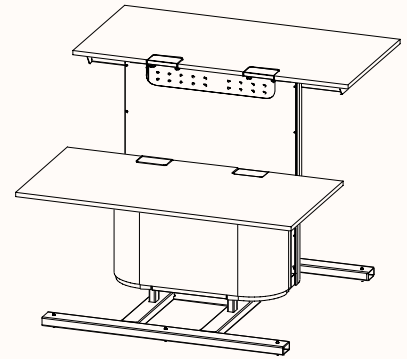

### Capsule Plus Pod 2 with Access Floor Base

(Floating Base)

Table length range: 1400 - 1800mm

Table depth range: 750-900mm

Suitable for use as a Work-point\*\* setting

Available with Click-in Lids which provide quick and easy access to Power/data outlets under the worktop.

Capsule shaped. The quantity of lids is calculated to ensure ease of use.

**Note \*\*** Work-point settings: Quantity of 2 Work-points must be specified.

The individual work-point length limitations are minimum 1200mm to maximum 2400mm.

Each work-point on the table will be equal in length.

### Height Range

Electric Adjust: 670 – 1200mm

### Options

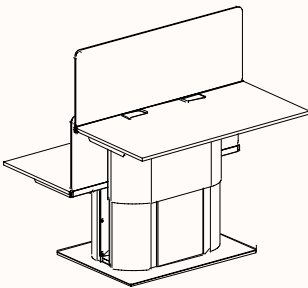

### Ctrl Screen Rail & Ctrl Screen

Compatible with Ctrl Screen Rail

(Worktop Mounted) & Ctrl Screen

Rear worktop to Ctrl Rail gap = Zero only