

# Cable Management



## CONTENTS:

Cable Hub	<a href="#">2</a>
Wire Basket	<a href="#">4</a>
Services Mounting Plate	<a href="#">5</a>
Cable Sleeve with ABS	<a href="#">6</a>
Cable Tractor	<a href="#">7</a>
Rectangular Umbilical	<a href="#">8</a>
96mm Duct Mounted on Z Bracket & Vertical Bracket	<a href="#">9</a>
Duct Bridges	<a href="#">10</a>
Cable Duct	<a href="#">11</a>
Hinged Front Cable Box	<a href="#">12</a>
86mm Under Desk Box (Fixed Height)	<a href="#">13</a>
86mm Under Desk Box (Variable Size)	<a href="#">14</a>
Cable Tray Open & Closed	<a href="#">15</a>
Hinged Cable Tray	<a href="#">17</a>
70mm Cable Cover	<a href="#">18</a>

# Cable Hub – 500mm

## Features:

The Cable Hub has two sets of mounting brackets at each end and can be fixed to the worktop at two different heights. Please ensure it will not clash with other items fixed underneath the worktop such as table support beams or in-desk boxes.

## Options:

- Cable Hub
- Cable Hub with Cable Sleeve
- Cable Hub with Tractor

## Finishes:

### 100% Recyclable PET:



Mid-Grey

### Powder coated Mounting Brackets:



Warm  
Grey



Cool  
Grey

## Dimensions:

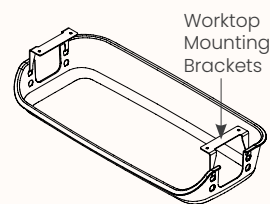

### Cable Hub

Length Range	530mm
	500mm (Internal)
Depth Range	250mm
Overall Height	100mm ; 125mm

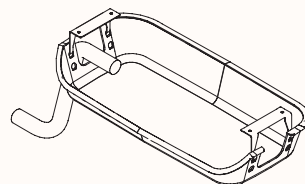

### Cable Hub with Cable Sleeve

Length Range	530mm
	500mm (Internal)
Depth Range	250mm
Overall Height	100mm ; 125mm

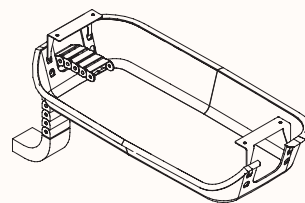

### Cable Hub with Tractor

Length Range	530mm
	500mm (Internal)
Depth Range	250mm
Overall Height	100mm ; 125mm

# Cable Hub – 950mm

## Features:

The Cable Hub has two sets of mounting brackets at each end and can be fixed to the worktop. Please ensure it will not clash with other items fixed underneath the worktop such as table support beams or in-desk boxes.

## Options:

- Cable Hub
- Cable Hub with cable sleeve
- Cable Hub with Tractor

## Finishes:

### 100% Recyclable PET:



Mid-Grey

### Powder coated Mounting Brackets:



Warm  
Grey



Cool  
Grey

## Dimensions:

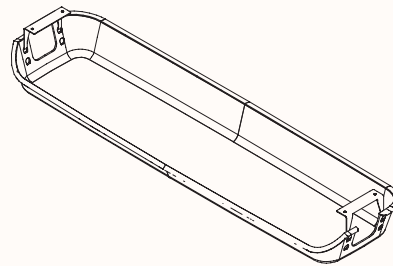

### Cable Hub

Length Range	980mm 950mm (Internal)
Depth Range	250mm
Overall Height	100mm ; 125mm

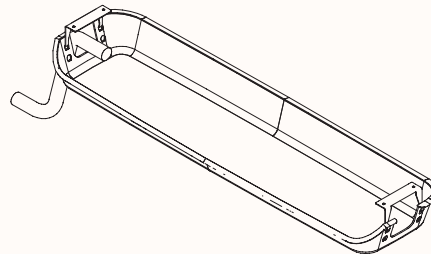

### Cable Hub with Cable Sleeve

Length Range	980mm 950mm (Internal)
Depth Range	250mm
Overall Height	100mm ; 125mm

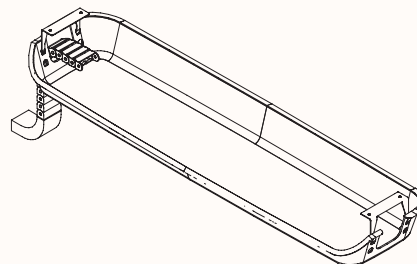

### Cable Hub with Tractor

Length Range	980mm 950mm (Internal)
Depth Range	250mm
Overall Height	100mm ; 125mm

# Wire Basket

## Wire Basket - 950mm

### Features:

Wire Baskets are made of wire mesh folded into a range of standard basket sizes. The worktop mounting brackets are welded to the mesh and the basket is then powder coated. The basket height/depth depends on the worktop mounting brackets.

### Options:

- Single Sided
- Double Sided

### Finishes:

#### Powder coat:



Black  
Ace



Warm  
Grey



Cool  
Grey



Warm  
White



Cool  
White

### Dimensions:

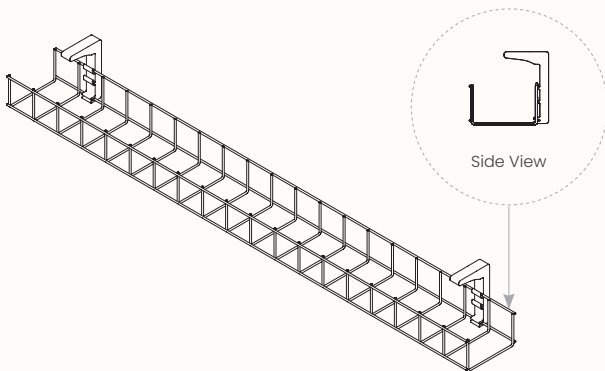

Length Range	950mm
Depth Range	50mm
Overall Height	50mm

# Services Mounting Plate

## Features:

The Services Mount Plate is a simple folded sheet metal part to suit required power and data softwiring outlets. The overall plate size is fixed, and are available two types of plates – dual and quad.

## Options:

- Dual plate fit 2x data and 2x GPO
- Quad plate can fit 2x data and 4x GPO

## Finishes:

### Powder coat:



Black  
Ace



Warm  
Grey



Cool  
Grey



Warm  
White



Cool  
White

## Dimensions:

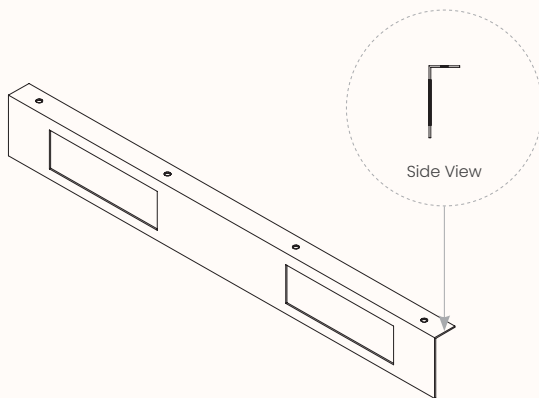

Length Range	520mm
Depth Range	25mm
Overall Height	65mm

# Cable Sleeve with ABS

## Features:

The braided Cable Sleeve cleverly conceals the under desk cabling on all Zenith workstations. Designed with a loop at each end to attach the sleeve to the worktop and ducting or floor. Each sleeve can house a maximum of 2 power and 5 data cables. The Sleeve is a textured fabric with a matching ABS guide. It is located inside the braided Cable Sleeve to stiffen the fabric giving it a more rigid appearance. The ABS strip can be removed if desired.

## Finishes:

### Fabric:



Black



Grey



White

## Dimensions:

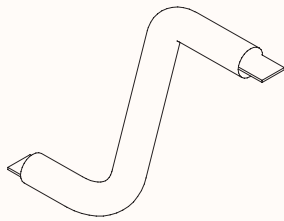

DIA	25mm
Length Range	1000mm

# Cable Tractor

## Features:

The Cable Tractor carries cables from the duct to the worktop and is mainly suited to height adjustable desks. It comes with end brackets and fasteners and has no internal segregation.

## Finishes:

### Powder coat:



Black  
Ace



Warm  
White



Cool  
White

## Dimensions:

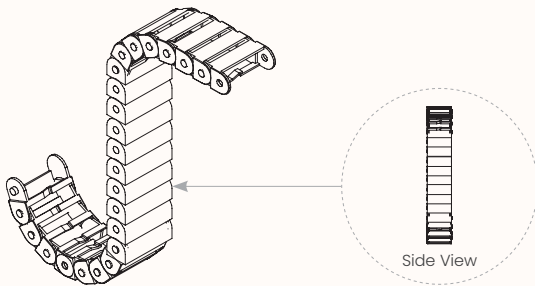

Length Range	50mm
Depth Range	20mm
Overall Height	1000mm

# Rectangular Umbilical

## Features:

The Rectangular Umbilical carries cables from the duct to the worktop and is mainly suited to height adjustable desks. There are two types of mounting brackets to suit different desk systems:

### Rectangular Umbilical – Horizontal Cable Management

- Standard 96mm duct frame mounted on Orbis & Rumba
- Rumba 96mm dropped duct

The umbilical comes in a 1m length and comes in a 1m length. The umbilical segment is approx. 68mm x 36mm and has internal segregation into 4 compartments.

### Rectangular Umbilical – Vertical Cable Management

The Rectangular Umbilical carries cables from the access floor to the worktop and comes with a floor base at one end and a worktop mounting bracket at the other end. The umbilical comes in a variety of lengths to suit different desk applications:

- 750mm L (suits 720 / 750H fixed height desks)
- 900mm L (suits 900H fixed height desks)
- 1050mm L (suits 1050H fixed height desks)
- 1300mm L (suits electric adjust desks)

The umbilical segment is approx. 68mm x 36mm and has internal segregation into 4 compartments.

## Finishes:

### Powder coat:



Black



White

## Dimensions:

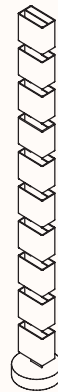

Length Range	68mm
Depth Range	36mm
Overall Height	750/900/1000/1050/1300mm

# 96mm Duct Mounted on Z Bracket / Vertical Bracket

## 96mm Duct Mounted on Z Bracket

### Features:

The 96mm Duct can be fixed to the worktop using Z-brackets. The Z-brackets offset the duct to give flexibility in the mounting position and avoid other items under the worktop.

### Finishes:

#### Powder coat:



Black Ace



Warm Grey



Cool Grey



Warm White



Cool White

### Dimensions:

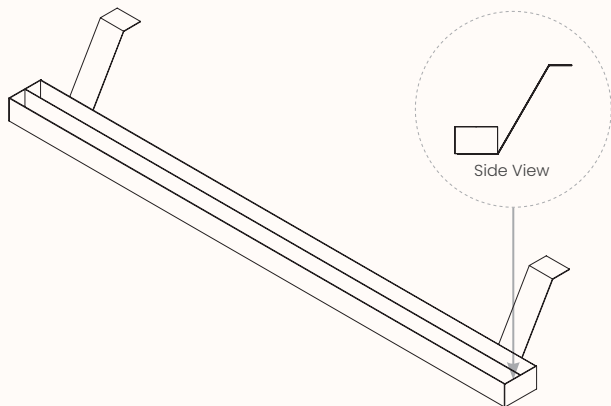

Length Range	500-2700mm
Depth Range	236mm
Overall Height	160mm

## 96mm Duct Mounted on Vertical Bracket

### Features:

The 96mm Duct can be fixed to the worktop using vertical brackets. The Vertical Brackets provide a smaller footprint and give flexibility in the mounting position and avoid other items under the worktop.

### Finishes:

#### Powder coat:



Black Ace



Warm Grey



Cool Grey



Warm White



Cool White

### Dimensions:

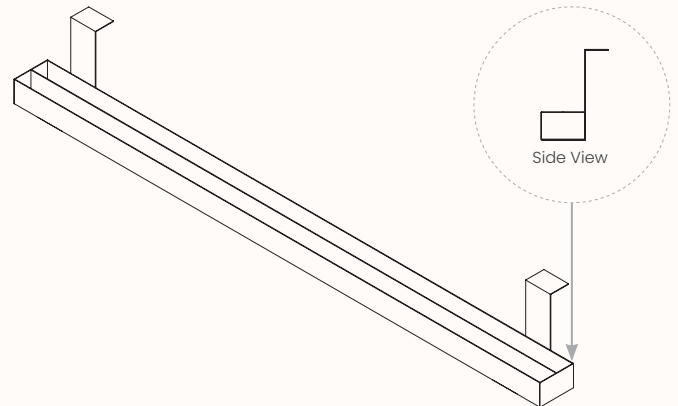

Length Range	500-2700mm
Depth Range	149mm
Overall Height	160mm

# Duct Bridges

## Features:

Australian standards require electric height adjustable desks to be separated by a 25mm gap (minimum). This is a safety measure to reduce the risk of injury to users. Duct Bridges are available to physically space Orbis and Rumba workstations 25mm apart and to conceal the cables between adjoining desks. The type of Duct Bridge depends on the desk configuration, screen type & duct type.

## Options:

- To suit Single Desk
- To suit Pod

## Finishes:

### Powder coat:



Black  
Ace



Warm  
Grey



Cool  
Grey



Warm  
White



Cool  
White

## Dimensions:

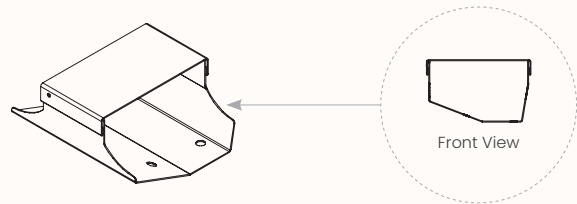

### Single Desk Duct Bridge

Length Range	216mm
Depth Range	177mm
Overall Height	61mm

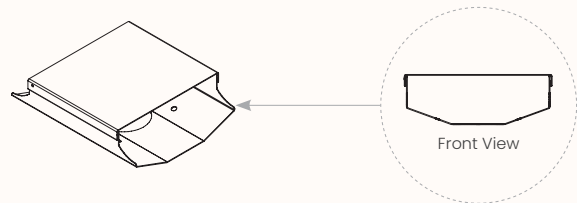

### Workpod Desk Duct Bridge

Length Range	216mm
Depth Range	177mm
Overall Height	61mm

# Cable Duct

## Features:

The Cable Duct is a simple folded sheet metal part with variable sizing. The length, width, height and front flange height of the Cable Duct are variable. The Cable Ducts are compatible with all workstations/tables.

## Finishes:

### Powder coat:



Black  
Ace



Warm  
Grey



Cool  
Grey



Warm  
White



Cool  
White

## Dimensions:

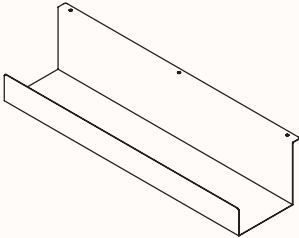

Length Range	min 300 to max 1250mm
Depth Range	min 90 to max 150mm
Overall Height	min 90 to max 150mm

# Hinged Front Cable Box

## Hinged Front Cable Box

### Features:

The Cable Box is folded sheet metal and has a hinged door to give access to internal cabling. The door has a magnetic closure and there is a cutout at each end of the Cable Box for cables to pass through. The length, width and height of the Cable Box & hinged door are variable. The hinged-front Cable Boxes are compatible with all workstations/tables.

### Finishes:

#### Powder coat:



Black  
Ace



Warm  
Grey



Cool  
Grey



Warm  
White



Cool  
White

### Dimensions:

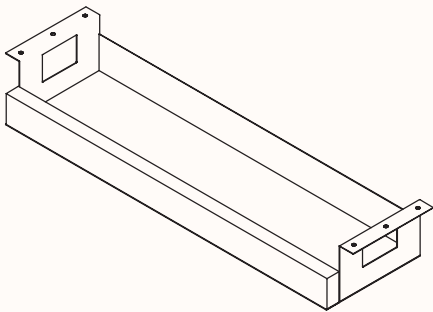

Length Range	min 400 to max 1300mm
Depth Range	min 150 to max 300mm
Overall Height	min 90 to max 250mm

# 86mm Under Desk Box (Fixed Size)

## Features:

The 86mm Cable Box suits 86mm sockets.

There are 4 types of 86mm Cable Boxes:

Single Row Type A, Single Row Type B, Double Row Type A, Double Row Type B.

For each type of 86mm cable box there are 4 standard sizes available: 310mm, 410mm, 510mm, 610mm

The 86mm cable boxes are compatible with all workstations/tables.

## Finishes:

### Powder coat:



Black  
Ace



Warm  
Grey



Cool  
Grey



Warm  
White



Cool  
White

## Dimensions:

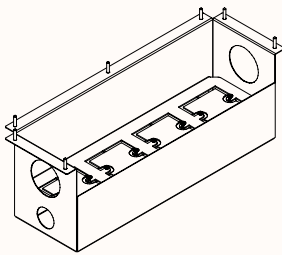

### Single Row - Type A: 3, 4, 5 or 6 sockets

Length Range	310mm / 410mm / 510mm / 610mm
Depth Range	150mm
Height Range	150mm

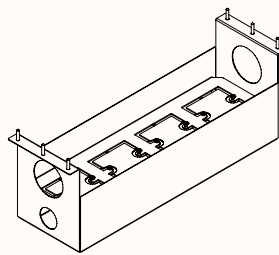

### Single Row - Type B: 3, 4, 5 or 6 sockets

Length Range	310mm / 410mm / 510mm / 610mm
Depth Range	130mm
Height Range	150mm

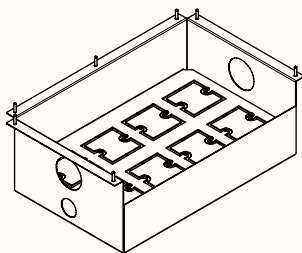

### Double Row - Type A: 6, 8, 10, or 12 sockets

Length Range	310mm / 410mm / 510mm / 610mm
Depth Range	260mm
Height Range	150mm

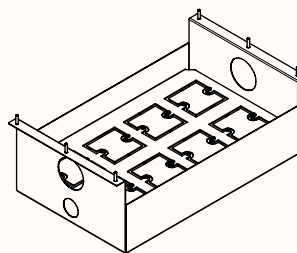

### Double Row - Type B: 6, 8, 10, or 12 sockets

Length Range	310mm / 410mm / 510mm / 610mm
Depth Range	260mm
Height Range	150mm

# 86mm Under Desk Box (Variable Size)

## 86mm Under Desk Box (Variable Size)

### Features:

The 86mm Cable Box suits 86mm sockets.  
 There are 3 types of 86mm Cable Boxes:  
 Single Row Type A, Single Row Type B, Double Row Type B.

For each type, it comes in various sockets. The 86mm cable boxes are compatible with all workstations/tables.

The Single Row boxes can have the sockets assembled on the LH or RH end. The Double Row box has the sockets assembled to the centre.

### Finishes:

#### Powder coat:



Black Ace



Warm Grey



Cool Grey



Warm White



Cool White

### Dimensions:

Length Range 710-1400mm  
 Depth Range 130-250mm  
 Height Range 100-250mm

### Single Row - Type A:

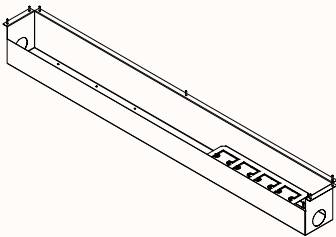

4 Sockets

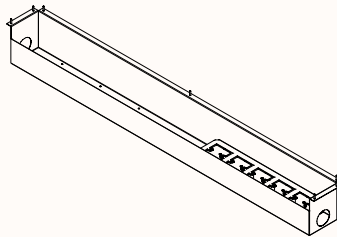

5 Sockets

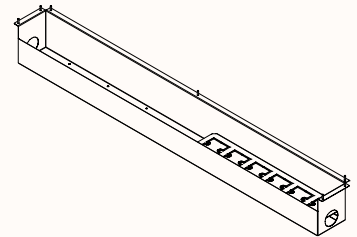

6 Sockets

### Single Row - Type B:

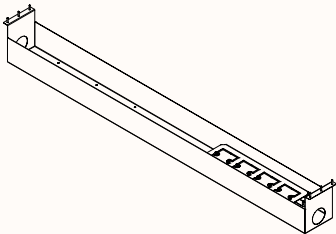

4 Sockets

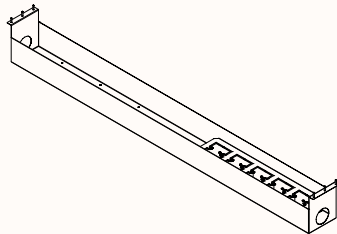

5 Sockets

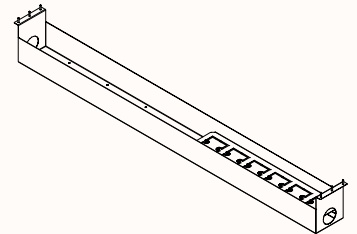

6 Sockets

### Double Row - Type B:

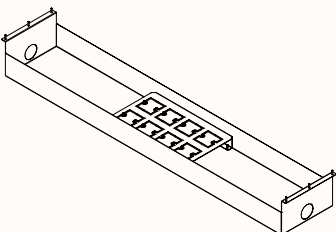

8 Sockets

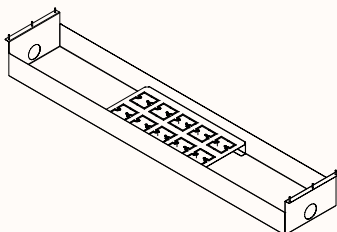

10 Sockets

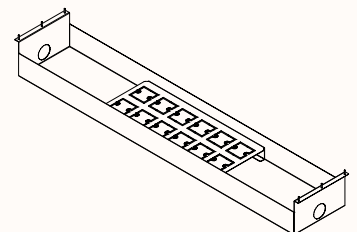

12 Sockets

# Cable Tray Closed & Open

## Cable Tray Open

### Features:

The Open Cable Tray is a folded & powder coated sheet metal tray and is available in two types – ‘flange in’ and ‘flange out’. The open Cable Tray has a range of fixed standard sizes.

The Open Cable Tray can also be ordered as variable. For variable trays the length, width, height and flange height must be specified for each order. The ‘flange out’ variable tray has optional closed ends. The Open Cable Trays are compatible with all workstations/tables.

### Finishes:

#### Powder coat:



Black  
Ace



Warm  
Grey



Cool  
Grey



Warm  
White



Cool  
White

### Dimensions:

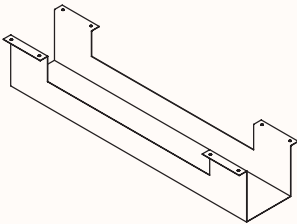

Length Range	520mm ; 800mm ; 1000mm
Depth Range	150mm
Overall Height	150mm

## Cable Tray Closed

### Features:

The Closed Cable Tray is a folded & powder coated sheet metal tray and is available in two types – ‘flange in’ and ‘flange out’. The ‘flange in’ type has a smaller footprint but requires two slots on the bottom face to give access to the fasteners. The ‘flange out’ type has a bigger footprint but has no slots on the bottom.

The length, width, height, front & back flange height of the Closed Cable Tray are variable and must be specified for each order. The Closed Cable Trays are compatible with all workstations/tables.

### Finishes:

#### Powder coat:



Black  
Ace



Warm  
Grey



Cool  
Grey



Warm  
White



Cool  
White

### Dimensions:

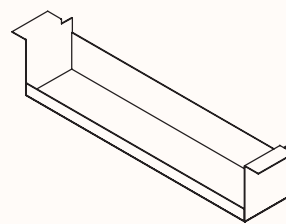

Length Range	min 400 to max 1300mm
Height Depth	min 90 to max 250mm min 150 to max 300mm

# Top Mount Plates

## Features:

Top Mount Plates are folded sheet metal parts which fix to the underside of the worktop to house power/data outlets. The Top Mount Plates are designed to seamlessly integrate with other cable management products such as the Worktop Mount Duct.

## Finishes:

### Powder coat:



Black  
Ace



Warm  
Grey



Cool  
Grey



Warm  
White



Cool  
White

## Dimensions:

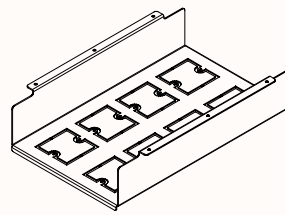

### TMP3C

#### 86mm Socket x 8

Length Range	416mm
Depth Range	286mm
Height Range	98mm

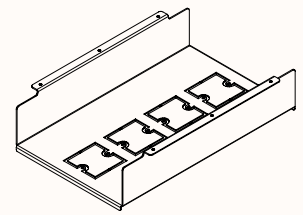

### TMP2C

#### 86mm Socket x 4

Length Range	416mm
Depth Range	286mm
Height Range	98mm

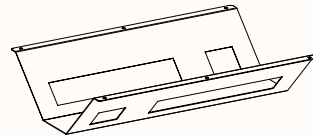

### CMS/Elsafe TMP1A

#### 2x Quad GPO & 2x Data

Length Range	410mm
Depth Range	284mm
Height Range	90mm

# Hinged Cable Tray

**Features:**

The Hinged Cable Tray is a folded sheet metal tray that fixes to the worktop and can easily hinge open to access internal cabling and components. The tray comes with a cutout for mounting a quad GPO, cutouts for fitting excess cabling/plugs, slots for cable ties and fixing holes for the option of mounting an electric adjust control box.

**Finishes:**

Powder coated in Zenith Select Finishes  
Please refer to Powdercoat Specification Sheet

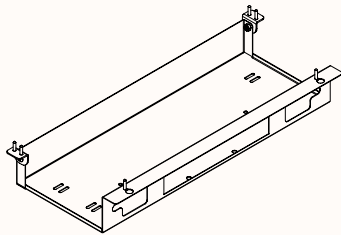
**Dimensions:****Hinged Cable Tray**

Length	540mm
Depth	222mm
Height	70mm

# 70mm Cable Cover

## Features:

The 70mm Cable Cover carries cables from the floor to the underside of the worktop and suits 70mm diameter Orbis legs. The cover is available in 3 types to suit a range of applications.

### Type A:

- Suits electric adjust legs, or fixed height legs with crossbeam/screen arm/duct arm
- Comes with a rectangular umbilical
- Umbilical can be specified as black or white finish
- The umbilical can be assembled on site in 2 orientations depending on the desired cable reticulation path
- The cable cover extrusion can be powder coated to match the desk frame finish

### Type B:

- Suits Orbis Ombre fixed height workstations only
- Suits legs with no crossbeam/screen arm/duct arm
- Runs from the floor up to the underside of the table support frame
- The cable cover extrusion can be powder coated to match the desk frame finish

### Type C:

- As per Type A, but with a braided cable sleeve instead of the umbilical
- Cable sleeve can be specified as Black or White finish
- The cable cover extrusion can be powder coated to match the desk frame finish

## Dimensions:

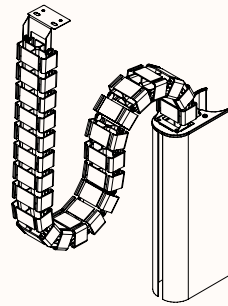

### Type A

Height 350mm



### Type B

Height To suit Fixed Height desk height

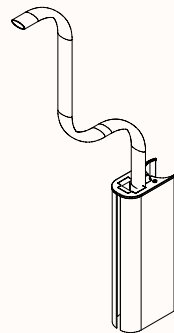

### Type C

Height 350mm