

# ADD Lounge System



## Features:

Highly customizable, its superior modularity embraces all dimensions. Two types of recycled diecast aluminium legs, one for corners and another to connect frames for larger configurations. Each leg type is available in two heights. Backrests and accessories can be fixed to the frame in several positions by using existing holes. Cushions and backrests in moulded polyurethane foam with polyester fiber, all fire-retardant, upholstered with removable fabric, soft leather or eco-leather.

See Add Lounge System Components Specification for individual component dimensions.

## Options:

- Two-tone upholstery
- Table tops
- Tray
- Magazine rack
- 90° revolving table case

**Design:** FRANCESCO ROTA for LAPALMA

**Warranty:** 5 years

**Certifications:** FSC

**Awards:** German Design Award Special 2016, Reddot Award Winner 2016, ADI Index Design, Compasso d'Oro ADI 2016 - honourable mention

## Finishes:

Upholstery in fabric collection categories A, B, C, D or leather

Refer to Lapalma Finishes Specification

Powder coat base: Black or white

HPL Fenix Black or White 40DIA pivoting top, tray, magazine rack and box for sockets.

Timber or HPL Fenix top

## HPL Fenix & Powder Coat Colours:



Black

White

## Timber:



Blanched  
Oak

Black Open  
Pore

## Configurations

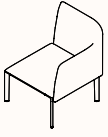

**One Seater**

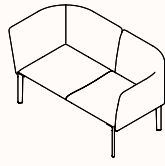

**Two Seater**

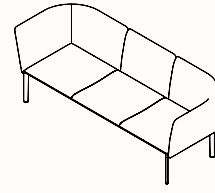

**Three Seater**

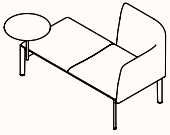

**Classic Mini**

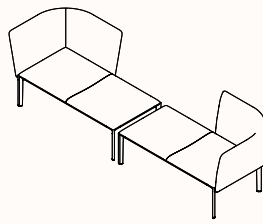

**Classic Mini - Double**

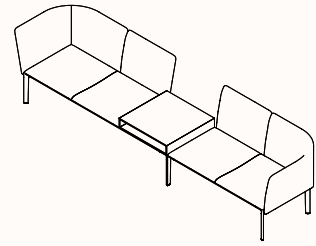

**Side by Side**

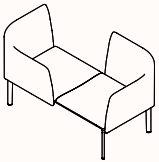

**Vis-a-vis Small**

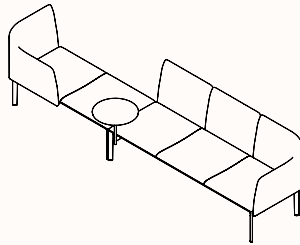

**Vis-a-vis Big**

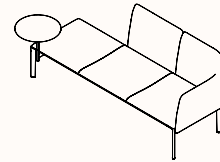

**Classic**

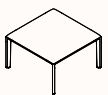

**Stool**

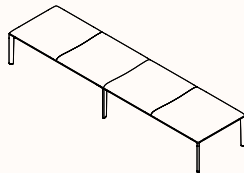

**Bench**

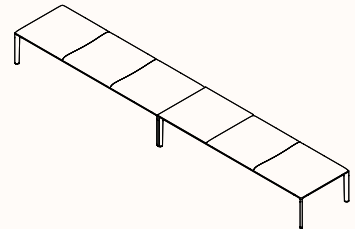

**Long Bench**

## Configurations

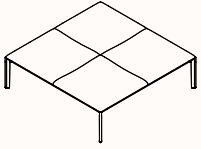

**Square Bench**

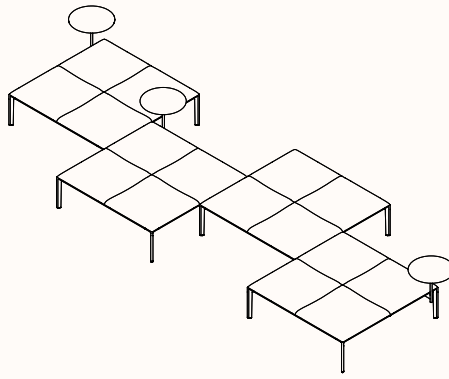

**Square Bench System**

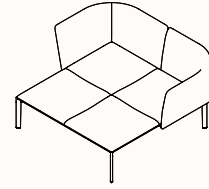

**Lounge**

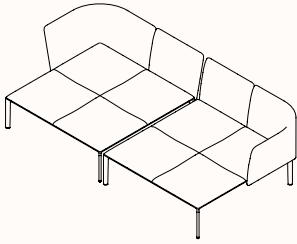

**Lounge - Double**

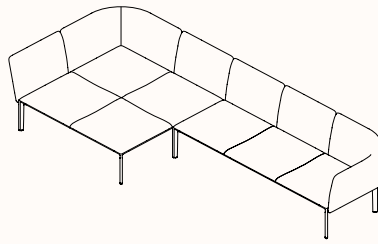

**Sofa**

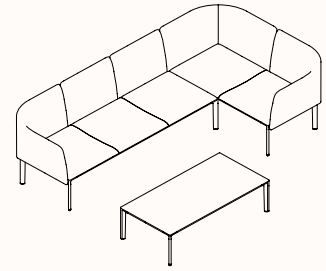

**L-Shape**

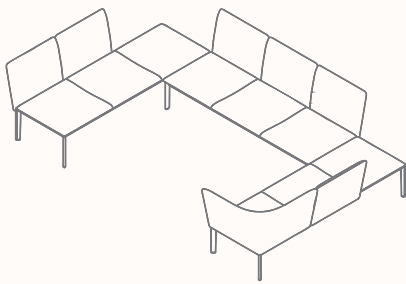

**C-Shape**

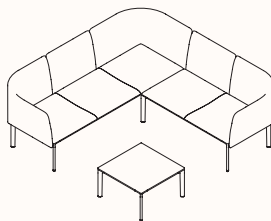

**L-Shape Big**

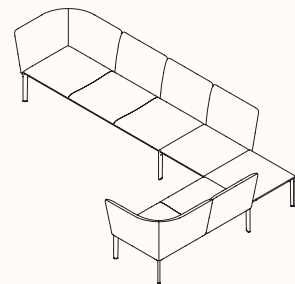

**L-Shape Open**

## Configurations

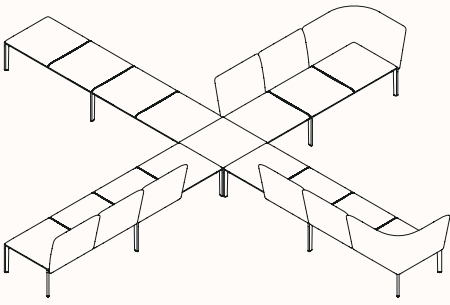

**X-Shape**

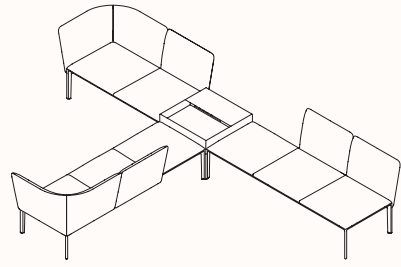

**T-Shape**

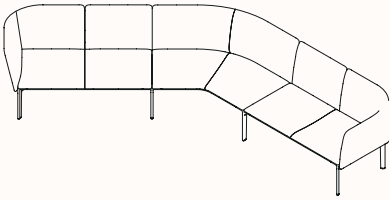

**V-Shape In**

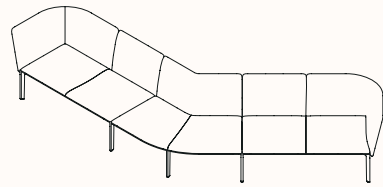

**V-Shape Out**

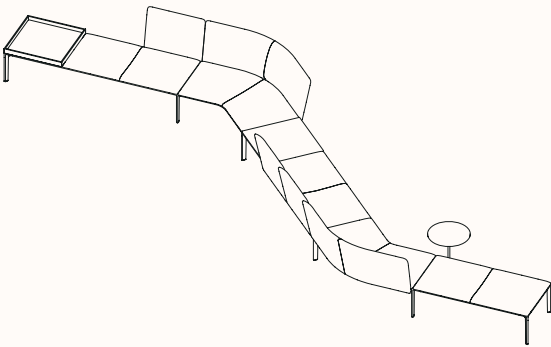

**S-Shape**

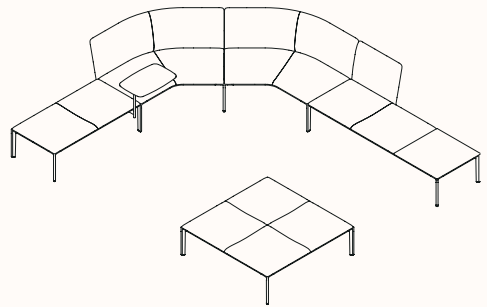

**Big Lounge**

## Configurations

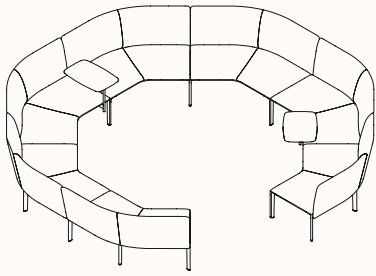

**Round In**

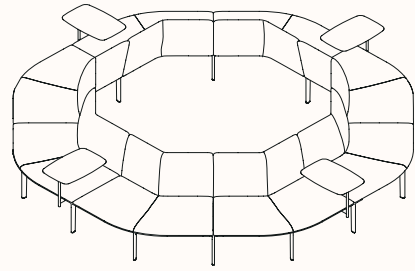

**Round Out**

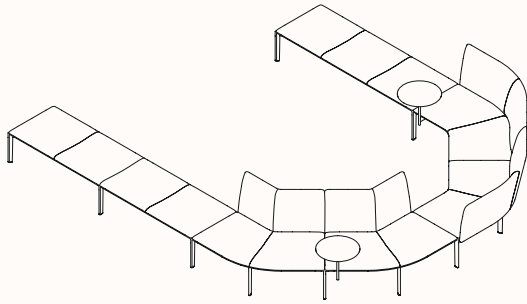

**U-Shape**

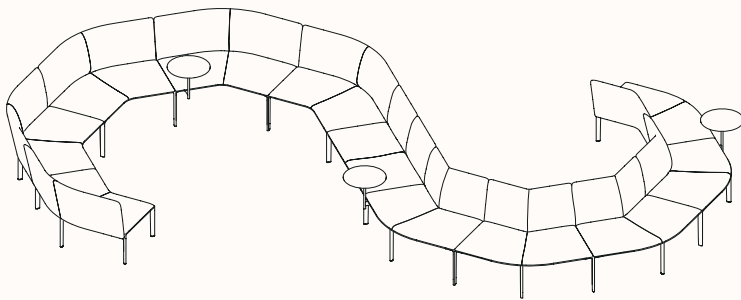

**S-Shape Big**